



Atlas All-in-One DC Charger User Manual (Atlas D80/120/160-US, Atlas D160-US-PRO)



Version: V1.0

Issuing date: 2024-05

Table of Contents

1. About this document	1
1.1 Function of this document	1
1.2 Statement	1
1.3 Target group	1
1.4 Revision history	1
1.5 Figures	1
1.6 Measuring unit	1
1.7 How to use this document	2
1.8 General symbols and signal words	2
1.9 Abbreviations	2
1.10 Orientation agreements	3
2. Description	4
2.1 Type plate	4
2.2 Application scenarios	4
2.3 Overview of charging system	5
3. Safety instructions	6
3.1 Handling	6
3.2 Installation	8
3.3 Use	8
3.4 Maintenance	8
4. Product description	9
4.1 Product parameters	9
4.2 Model description	11
4.3 Appearance and dimension	12
4.3.1. Overview of the DC charger, outside	12
4.3.2. Appearance and dimension description of external components of DC charger	13
4.4 Status indicator light	14
4.5 EV charging interface	15
4.5.1. CCS1	15
4.6 Interface description	16
4.7 Ventilation area	17
4.8 Schematic diagram of parallel operation	17
5. Installation instructions	18
5.1 Preparation before installation	18
5.1.1 Electrical preparation	18
5.1.2. Preparation of site and tools	19
5.2 Do a check before unpacking	20

5.2.1. Do a check on the transport sensors	20
5.2.2. Unpacking	20
5.2.3. Inspection of accessories	21
5.3 Installation	22
5.3.1. Preparation of foundation and auxiliary materials	22
5.3.2. Electrical wiring	23
5.4 Power on	23
5.5 Network inspection	24
5.6 Inspection of charging connector status	24
5.7 Parameter setting	25
5.7.1 Language setting	25
5.7.2. Function setting	25
6. Operation instructions	28
6.1 Software version	28
6.2 Charging operation	28
7. Maintenance instruction	32
7.1 Maintenance schedule	32
7.2 Cleanness of cabinet	33
7.2.1. Dust removal	33
7.2.2. Rust removal	33
7.3 Inspection of charger body	34
7.4 Cleanness and replacement of filter cotton	34
8. Troubleshooting	35
8.1 Troubleshooting procedure	35
8.2 Troubleshooting table	35
9. Contact	37

1. About this document

1.1 Function of this document

This document is only applicable for this EV charger (Atlas All-in-One DC charger).

This document provides the following information of Atlas All-in-One DC charger:

- Description
- Safety instructions
- Product description
- Installation instructions
- Operation instructions
- Maintenance instructions
- Troubleshooting
- Contact

1.2 Statement

- EV Charging Clean Energy Technology Co., Ltd. is not responsible for any damage, loss, cost or expense arising from the improper use of Atlas All-in-One DC charger, in particular any damage, loss, cost or expense arising from non-compliance with this document and relevant standards and laws and regulations.
- The pictures provided in this document are for reference only, and subject to the actual product.

1.3 Target group

This document is intended for:

- Qualified installation engineer
- Qualified Maintenance personnel
- Users of EV charger

1.4 Revision history

Version	Time	Description
V1.0	2024-05	Initial version

1.5 Figures

The figures do not fully show the configuration of the Atlas All-in-One DC charger, and only provide the guidance and description of the typical configuration.



1.6 Measuring unit

The International System of Units (metric system) is used. If necessary, the document shows other units between parentheses “()” or in separate columns in tables.

1.7 How to use this document

1. Make sure that you know the structure and contents of this document.
2. Read the safety chapter and make sure that you know all the instructions.
3. Do the steps in the procedures fully and in the correct sequence.
4. Keep the document in a safe location that you can easily access. This document is a part of the EV charger.

1.8 General symbols and signal words

Figure	Description
	<p>DANGER: It indicates that the operation must be based on the instructions. In case of failure to follow the instructions, it is possible to cause serious consequences, including but not limited to equipment damage, cost and property loss, injury or even death.</p> <p>Danger: Il indique que l'opération doit être basée sur des instructions. Le non - respect des instructions peut entraîner des conséquences graves, y compris, mais sans s'y limiter, des dommages à l'équipement, des dommages aux coûts et aux biens, des blessures et même la mort de personnes.</p>
	<p>WARNING: It indicates that the operation must be based on the instructions. In case of failure to follow the instructions, it is possible to cause serious consequences, including but not limited to equipment damage, cost and property loss, and injury.</p> <p>Avertissement: Il indique que l'opération doit être basée sur des instructions. Le non - respect des instructions peut entraîner des conséquences graves, y compris, mais sans s'y limiter, des dommages à l'équipement, des dommages aux coûts et aux biens et des blessures corporelles.</p>
	<p>NOTE: It indicates the supplementary instruction provided for the preceding text.</p> <p>Attention: Il représente la description complémentaire fournie pour le texte précédent.</p>

1.9 Abbreviations

Abbreviation	Definition
AC	Alternating Current
DC	Direct Current
EVCCE	EV Charging Clean Energy Technology CO., Ltd.
EV	Electric Vehicle
EVSE	Electric Vehicle Supply Equipment
PE	Protective Earth
RFID	Radio Frequency Identification
OCPP	Open Charge Point Protocol

1.10 Orientation agreements

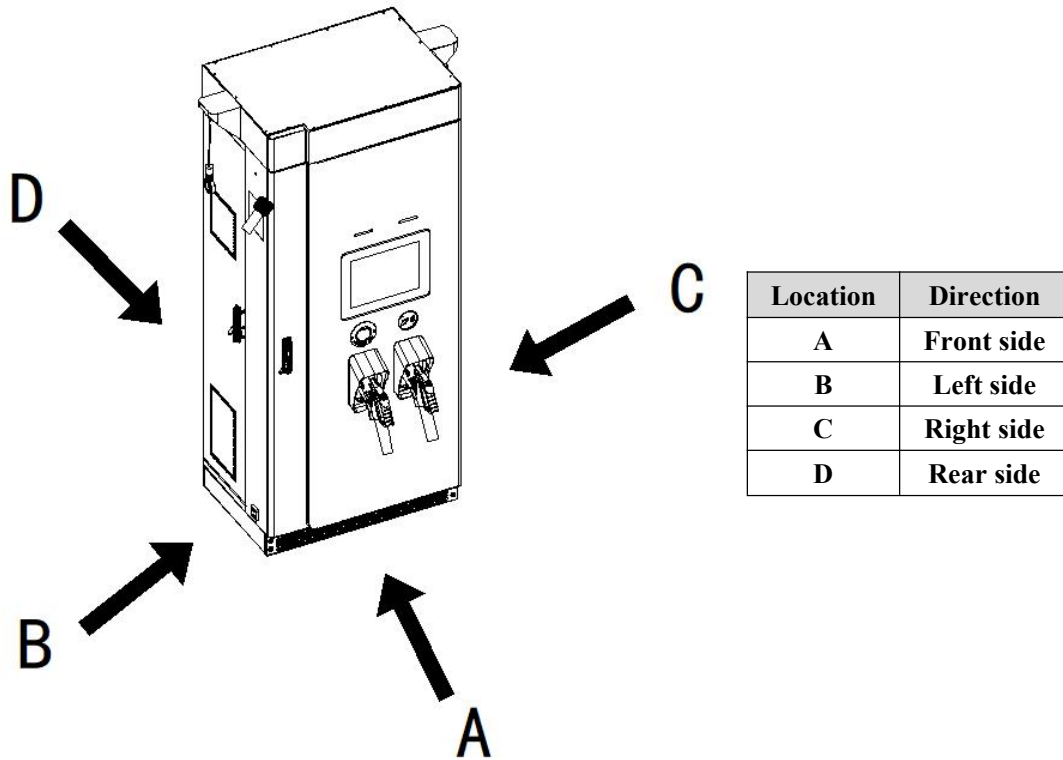

2. Description

2.1 Type plate

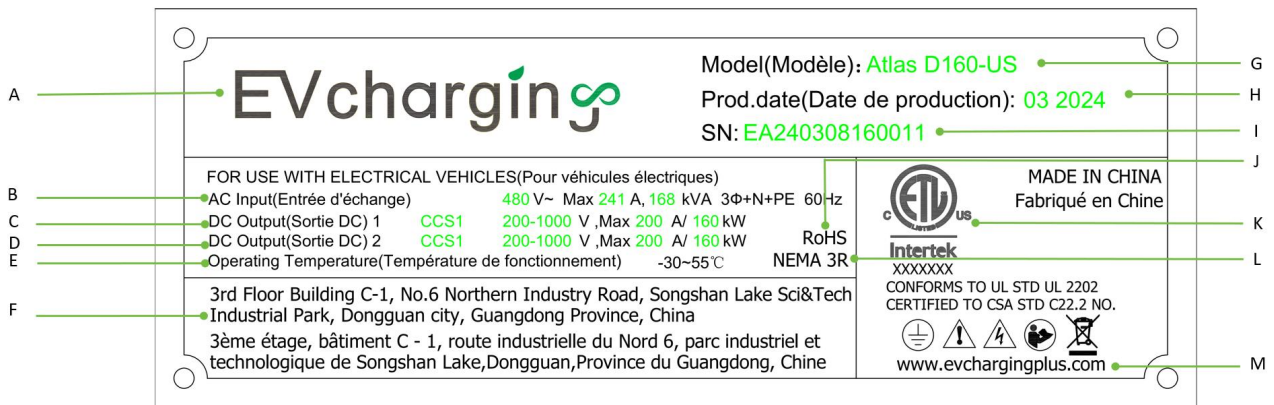

A	Manufacturer	B	AC input specification	C	Output specification of DC Connector 1
D	Output specification of DC Connector 2	E	Operating temperature	F	Manufacturer Address
G	Product model	H	Production date	I	Serial number
J	RoHS mark	K	UL mark	L	NEMA rating
M	Manufacturer's official website				

2.2 Application scenarios

1. Atlas DC charger is used for DC charging of electric vehicles indoor or outdoor.
2. The properties of the electrical grid, the ambient conditions and the EV must comply with the technical data of the charger.
3. Only use the EV charger with accessories that the manufacturer provides and that obey the local rules.

2.3 Overview of charging system

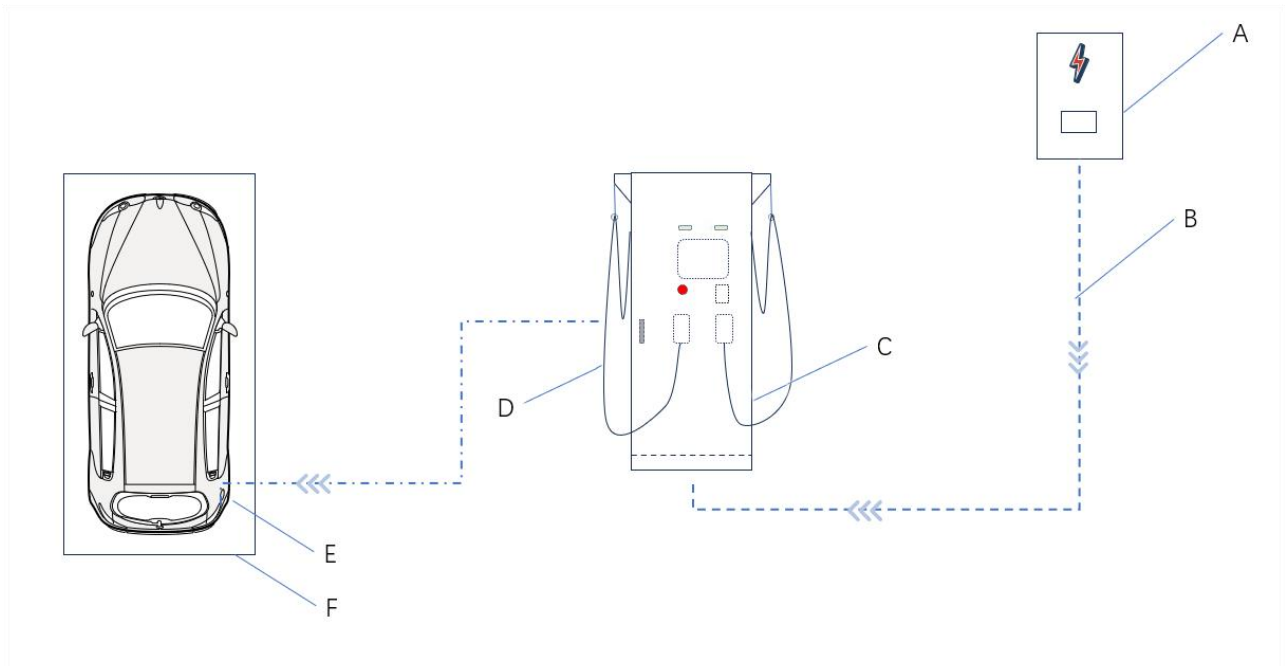

A	Power distribution board	B	AC input cable
C	Atlas DC charger	D	EV Charging cable
E	EV	F	Parking space

Terms	Interpretation
Power distribution board	Used to connect Atlas DC charger with an AC grid
AC input cable	Used to supply power to Atlas DC charger
Atlas DC charger	The product of EVCCE
EV charging cable	Used to charge the electrical vehicle by the vehicle management system
EV	The EV of which the batteries need to be charged
Parking space	The location of the EV during charging session

3. Safety instructions



Before handling, installing, using and maintaining Atlas series DC charger, please read this document carefully and strictly follow the safety instructions.

Lisez attentivement ce document et suivez scrupuleusement les consignes de sécurité avant de manipuler, installer, utiliser et entretenir les chargeurs CC de la série Atlas.

This document provide the safety instructions which should be followed during handling, installing, using and maintaining Atlas series DC charger. Please handle, install, use and maintain Atlas series DC charger strictly as instructed by this document.

Ce document fournit des instructions de sécurité à suivre lors de la manipulation, de l'installation, de l'utilisation et de l'entretien des chargeurs CC de la série Atlas. Veuillez utiliser, installer, utiliser et entretenir le chargeur CC Atlas Series en suivant strictement les instructions de ce document.

For Both FCC & IC application:

This device complies with Part 15 of the FCC Rules / Industry Canada licence-exempt RSS standard(s). Operation is subject to the following two conditions: (1) this device may not cause harmful interference, and (2) this device must accept any interference received, including interference that may cause undesired operation.

Le présent appareil est conforme aux CNR d'Industrie Canada applicables aux appareils radio exempts de licence. L'exploitation est autorisée aux deux conditions suivantes : (1) l'appareil ne doit pas produire de brouillage, et (2) l'utilisateur de l'appareil doit accepter tout brouillage radioélectrique subi, même si le brouillage est susceptible d'en compromettre le fonctionnement.

Changes or modifications not expressly approved by the party responsible for compliance could void the user's authority to operate the equipment.

This equipment has been tested and found to comply with the limits for a Class A digital device, pursuant to part 15 of the FCC Rules. These limits are designed to provide reasonable protection against harmful interference when the equipment is operated in a commercial environment. This equipment generates, uses, and can radiate radio frequency energy and, if not installed and used in accordance with the instruction manual, may cause harmful interference to radio communications. Operation of this equipment in a residential area is likely to cause harmful interference in which case the user will be required to correct the interference at his own expense.

MPE Requirements

To satisfy FCC / IC RF exposure requirements, a separation distance of 20 cm or more should be maintained between the antenna of this device and persons during device operation.

To ensure compliance, operations at closer than this distance is not recommended.

Les antennes installées doivent être situées de façon à ce que la population ne puisse y être exposée à une distance de moins de 20 cm. Installer les antennes de façon à ce que le personnel ne puisse approcher à 20 cm ou moins de la position centrale de l'antenne.

La FCC des états-unis stipule que cet appareil doit être en tout temps éloigné d'au moins 20 cm des personnes pendant son fonctionnement.

3.1 Handling

1. The charger is only handled by qualified and authorized personnel.
2. The handling personnel must wear appropriate personal protective equipment and comply with all health and safety requirements applicable to the work area.
3. Do not handle in rain or bad weather conditions. If impossible, take necessary protection measures.
4. The charger is integrated, and must not be disassembled during handling or installation. In case of modification without our authorization, the failure caused thereon will be excluded from the warranty.
5. Always pay attention to the center of gravity mark on the packing. Since the center of gravity is not the mechanical

center of the product, please always pay attention to the tipping indicator on the outer packing during transportation (see 5.2.1 Do a check on the transport sensors) to ensure the balance and stability of the charger.

6. Before moving the charger, make sure that the handling equipment can support the weight of the charger, check whether the pallet is in good condition, and ensure that the forklift can fully lift the pallet.
7. Ensure that all moving parts of the charger are fixed before handling.
8. Before handling, check whether the work site is safe (such as space of unloading area, bearing capacity of ground, and route safety meet the requirements).
9. Ensure that tilt angle $< 5^\circ$. If the tilt angle is too large, the charger may tip over due to its large size.
10. During handling, keep a safe distance from the charger to prevent crushing injury caused by tipping or collision.

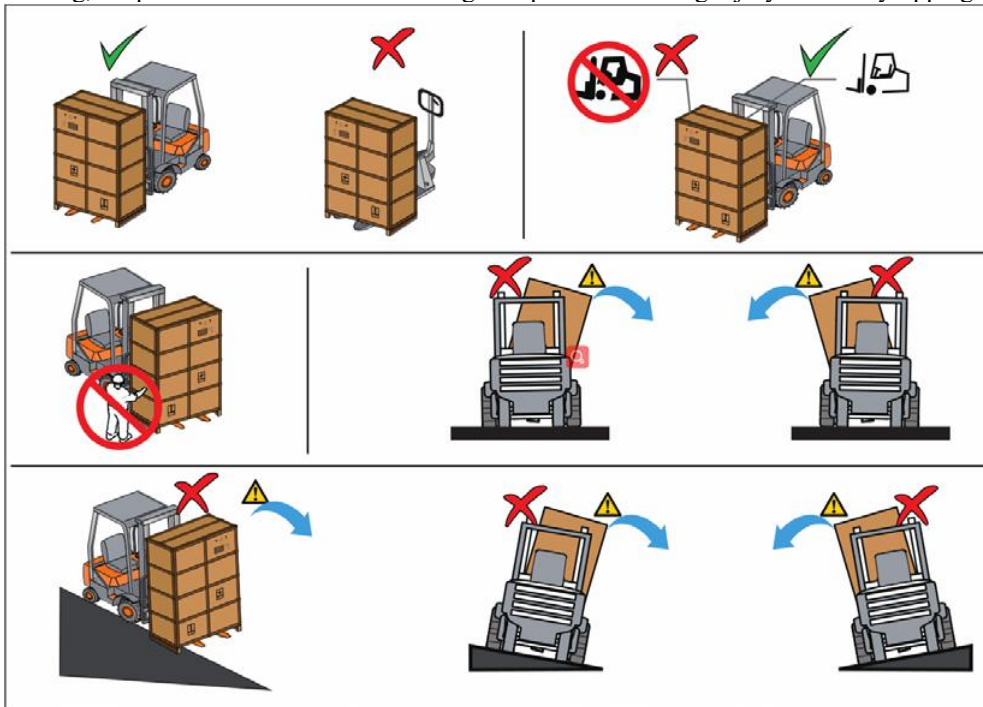

3.2 Installation

1. Do not install the charger in an environment with flammable or explosive gas or smoke.
2. The charger must be installed and used through a permanent wiring system or device.
3. The charger must be installed by the personnel who are trained and qualified to operate the electrical system. Other personnel is kept from safe distance during installation.
4. Before installing the charger, ensure that the installation position has sufficient space for the moving parts and ventilation and heat dissipation of the charger. For details, see [5.1.2 Preparation of Sites and Tools](#).
5. Before installing the charger, make sure that the circuit breaker inside the charger and the upper circuit breaker are deactivated.
6. Before connecting the power supply, please check whether the power supply conforms to the rated input value of the charger, and ensure that the switch on the charger is deactivated.
7. Before turning on the power supply, make sure that the ground cable is properly connected to the ground bar inside the charger and the ground hole reserved on the side of the charger.

3.3 Use

1. Do not directly spray high-pressure liquid to the charger and the connector and holder, or soak the charging connector in liquid.
2. After charging, please put the connector into the holder to avoid unnecessary pollution or moisture.
3. In case of potential safety hazard on the charger for its deflection, crack, wearing or otherwise damage, do not use the charger.
4. Do not attempt to disassemble or repair the charger or tamper with or modify the software and the set parameters. The ordinary users are disqualified for maintenance, if maintenance is required; please contact our after-sale service center or local distributor.
5. Do not insert fingers or foreign objects into any part of the charger.
6. Do not forcibly fold or press, hit any part of the charger, or damage it with sharp objects.
7. It is strictly prohibited to draw the charging connector to ensure personal and vehicle safety during charging process.
8. Please turn off the electric vehicle before charging. During the charging process, the electric vehicle is prohibited from driving and can be charged only when the electric vehicle is stationary.
9. Keep children away from the charger.
10. Do not operate the touch screen by sharp hard objects, such as screwdrivers or cards; otherwise, the touch screen may be cracked and damaged.
11. Do not use the charger in marine environment and outdoor and simple-sheltered environment near strong pollution sources. Otherwise, it is possible to cause failure, abnormal function or component damage for corrosion and moisture, which will be excluded from the warranty.
12. In case of use in offshore environment, it is possible to cause spot-like rust on the module shell or shorten the service life of the charger. If required, please consult the relevant service department for details. The offshore environment refers to the area which is 0.5m-3.7m from saltwater (sea).

3.4 Maintenance

1. The charger must be maintained by the personnel who are trained and qualified to operate the electrical system. Other personnel are kept from safe distance during the maintenance.
2. Before cleaning and maintaining, disconnect the input power of the charger.
3. Maintain the charger strictly according to the maintenance instructions provided in this document.
4. It is strictly prohibited to modify, add or remove the internal components of the charger without authorization.

4. Product description

4.1 Product parameters

Standard		UL standard		
Power		80kW	120kW	160kW
Model		Atlas D80-US	Atlas D120-US	Atlas D160-US Atlas D160-US-PRO
AC input	Voltage	480V AC		
	Current	≤178A	≤250A	≤241A
	Frequency	60Hz		
	Connection mode	3Φ+N+PE		
Output	Voltage	200V DC-1000V DC		
	Current	CCS1: Max 200A /300A (optional)/350A (optional)		CCS1: Max 500A
	Output interface	Two connectors: CCS1 + CCS1		
User interaction		15-inch touchscreen		
Communication interface		Ethernet, Wi-Fi, 4G		
Platform communication protocol		OCPP1.6J, OCPP2.0 ready		
Safety protection	Electrical Protection	Short circuit protection, over and under-voltage protection, over-temperature protection, surge protection, shock protection, grounding detection, insulation detection, phase loss detection, isolation transformer protection, lightning protection Leakage protection (AC input)		
	Structure Protection	Emergency stop button		
Compliance, safety		UL2202		
Certification		UL, RoHS		

Starting mode	Online	1. RFID: ISO 15693, ISO 14443A/B, NFC 2. POS equipment (visa, master card, Apple pay, Google pay, credit card /debit card) 3. APP 4. Support starting in VIN code, if GB/T connector is provided			
	Offline	1. Charging by password (by clicking the user interface on the screen) 2. RFID: ISO 15693, ISO 14443A/B, NFC			
Cabinet material	Stainless steel	Stainless steel	Stainless steel	Stainless steel	
Dimension	Standard model: 850*600*1880mm (W*D*H)			1110*600*2100mm (W*D*H)	
	Model with cable management system: 1110*600*2040mm (W*D*H)				
Cable length	Standard: 5m; Optional: 7m or customize the length according to the actual situation				
Cable management system	-			•	
Installation mode	Ground Mounting				
Storage temperature	-40°C to +80°C				
Operating temperature	-30°C+50°C, derated at more than 50°C				
Operating humidity	5%-95%				
Altitude	≤2000m, derated at more than 2000m				
Efficiency	≥95%				
Protection grade	3R, IK10 (screen IK08)				
Noise	≤60dB (A)				
Parallel function	-			•	
Product features	1. Support transport with modules and turn on without installing modules 2. Always online 3. Remote OTA upgrade				



"-" indicates that the configuration is not available, and "•" indicates that the configuration is available.

4.2 Model description

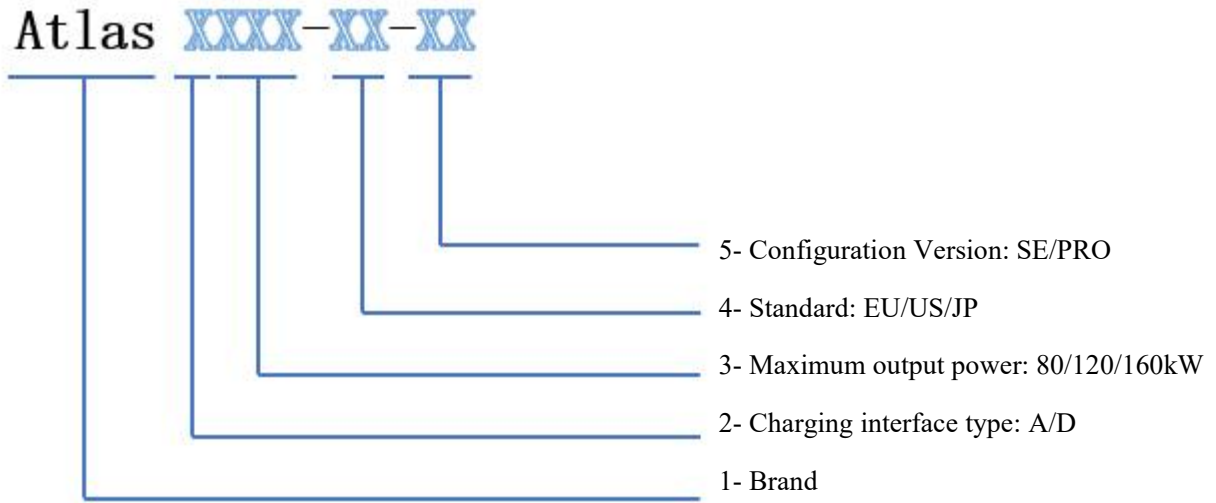

For example: Atlas D160-US: Atlas DC charger, DC output power 160kW, UL standard, standard version.

Model description		
No.	Terms	Description
1	Brand	Atlas: The product series of EVCCE
2	Charging interface type	A: AC charging interface, D: DC Charging interface
3	Maximum output power	80: 80kW, 120: 120kW, 160: 160kW.
4	Standard	EU: European standard, US: American standard, JP: Japanese standard
5	Configuration version	Default: standard version, PRO: Professional version

4.3 Appearance and dimension

4.3.1. Overview of the DC charger, outside

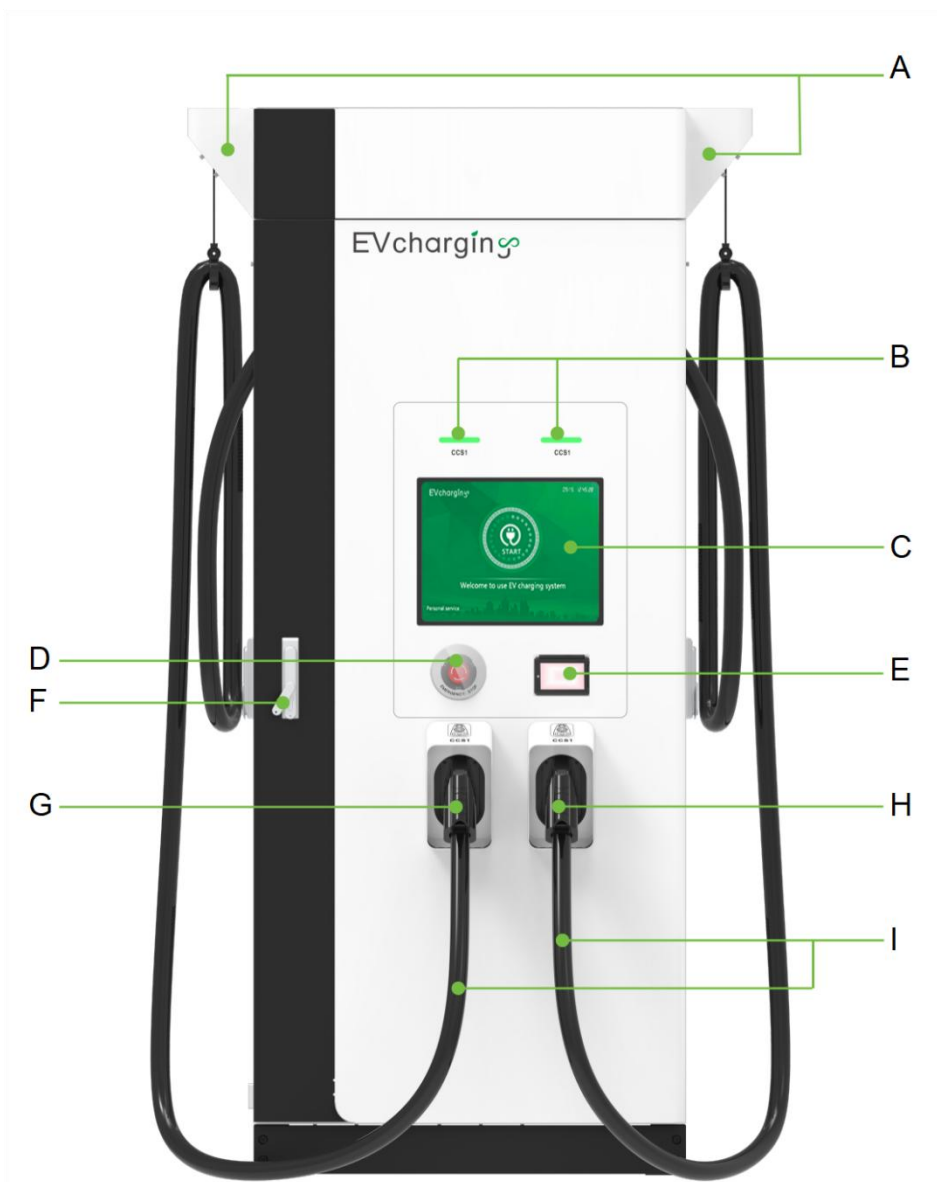

Description			
A	Cable management system (optional)	B	Indicator light
C	Touch screen	D	Emergency stop button
E	Integrated payment terminal (optional)	F	Lock
G,H	EV charging connector and holder	I	EV charging cable

4.3.2. Appearance and dimension description of external components of DC charger

(1) Atlas DC charger:

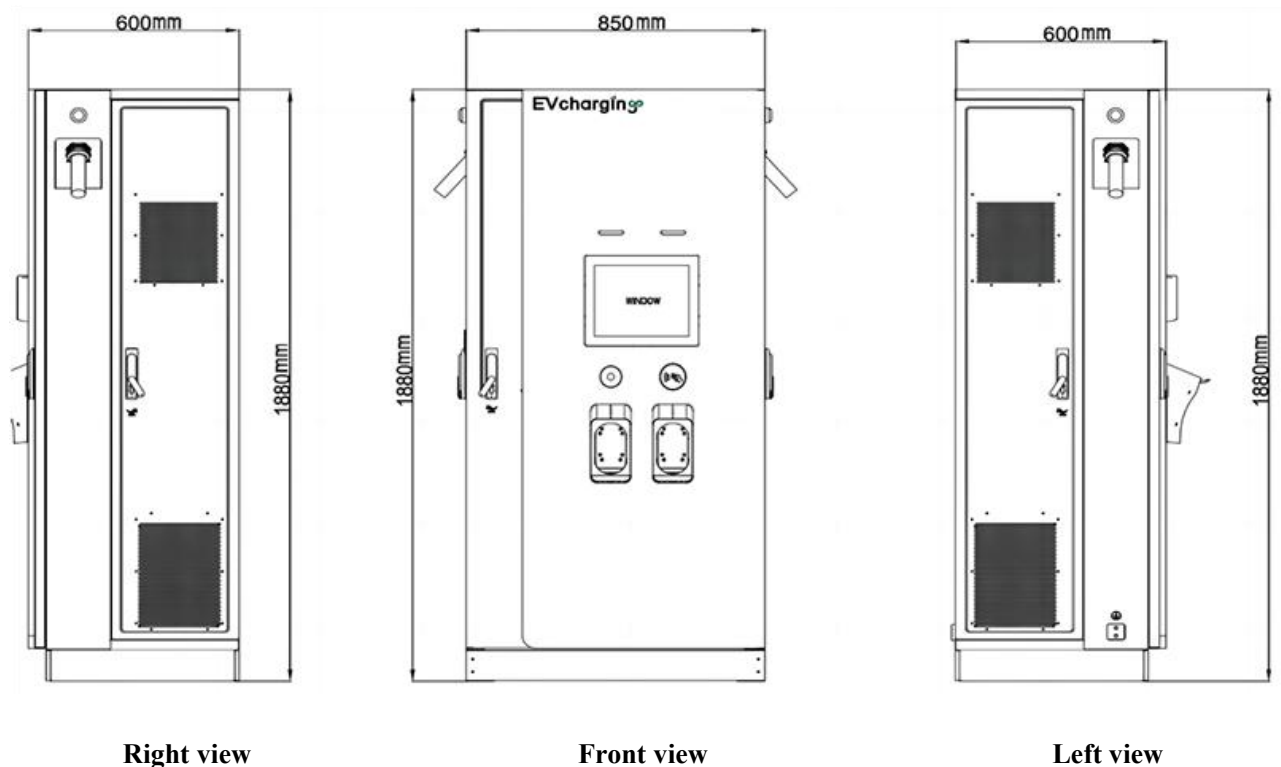

(2) Atlas DC charger with cable management system:

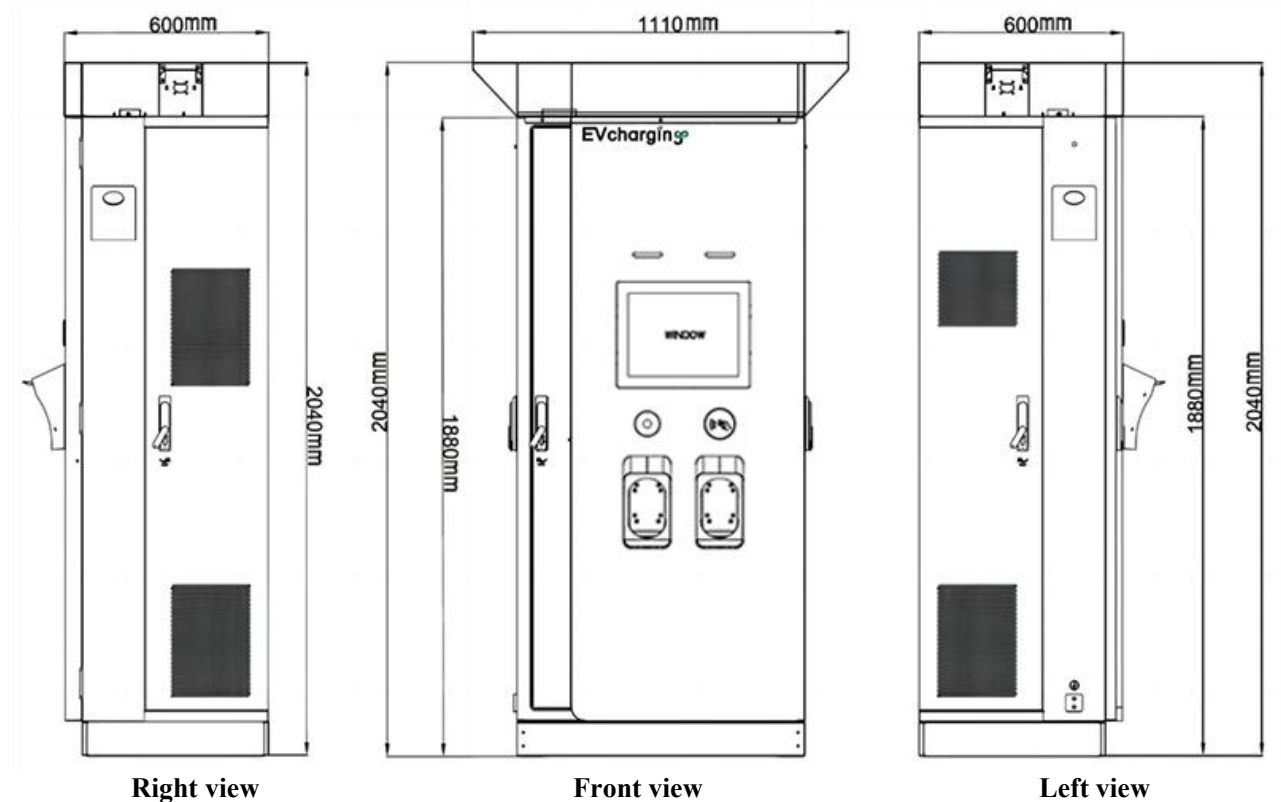

(3) Atlas series DC charger with liquid cooling and cable management system:

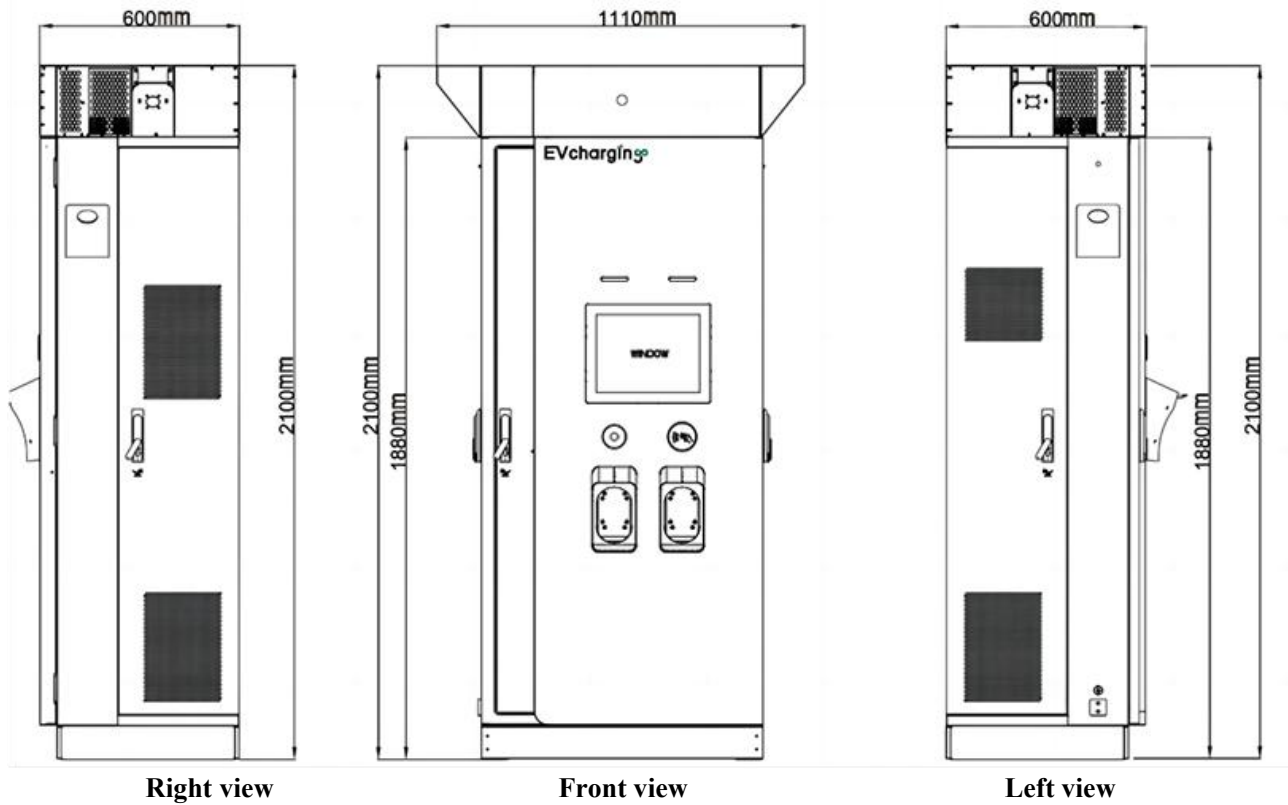

4.4 Status indicator light

Status	Color	Note
Online and available	Green light always on	The charger is online and idle without inserting of the connector.
Offline and available	White light always on	The charger is offline and idle without inserting of the connector.
Preparing	Green light flashing	The connector is inserted without charging
Starting	Blue light flashing	Starting
Reserved	Yellow always on	Online, booked, and connector not inserted
Charging	Blue waterfall light	
Suspended	Slowly flicker in yellow	
Unavailable	Normally on in red	
Finished	Green light flashing	Charging stopped
Upgrading	Normally on in red	Upgrade process
Error (secondary failure)	Normally on in red	For example: relay failure, current leakage, grid failure, ground contact fault
Error	Normally on in red	

4.5 EV charging interface

4.5.1. CCS1

The charging cable with CCS1 connector is for Atlas DC charger.

A	L1
B	N
C	PP
D	CP
E	PE
F	DC+
G	DC-

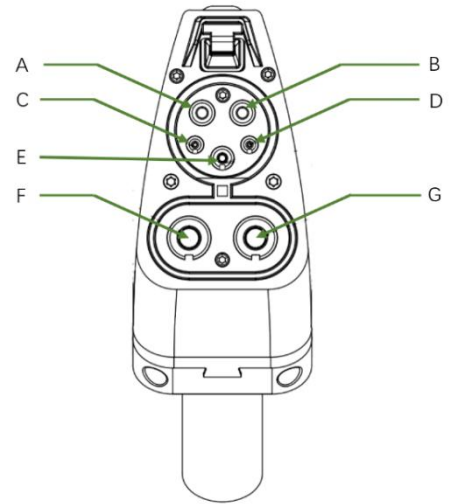

4.6 Interface description

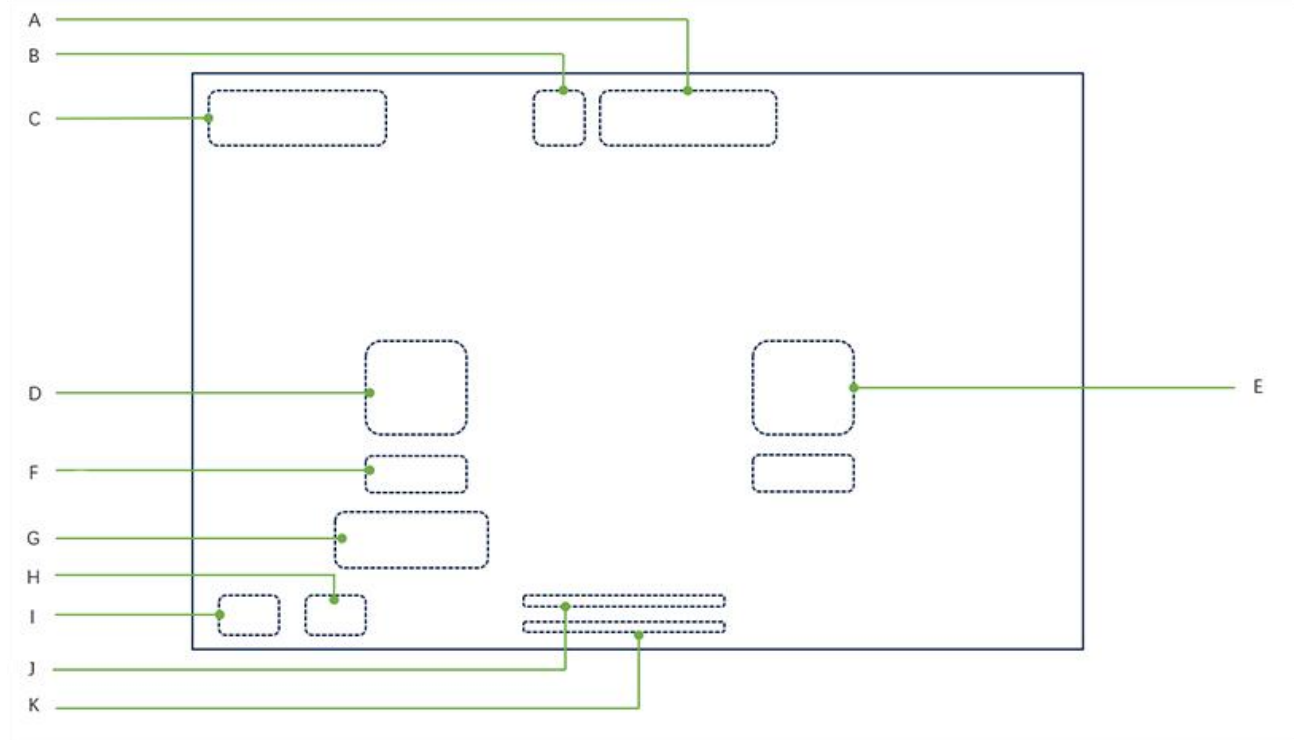

A	Date and time	B	Network connection status
C	Company logo	D	Connector 1
E	Connector 2	F	Charging status
G	Real-time charging information	H	Language
I	Setting	J	Charger ID
K	Current version of charger		
Date and time	The date and time may be inaccurate upon powering on the charger for first time. After connecting with the network, the date and time will be automatically synchronized.		

4.7 Ventilation area

Ventilation design of Atlas DC charger: the cold air is fed by the air inlet on its bottom , and the hot air is discharged by the air outlet on its top. To let cooling air in and out. The airflow makes sure that the parts on the inside of the EV charger do not become too hot.

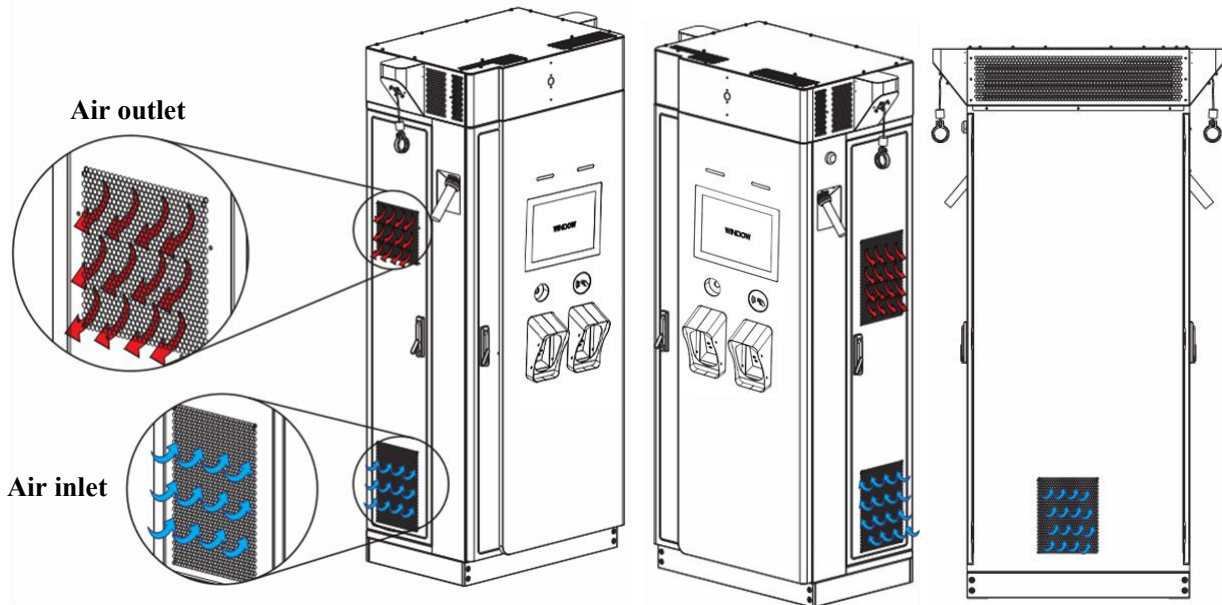

4.8 Schematic diagram of parallel operation

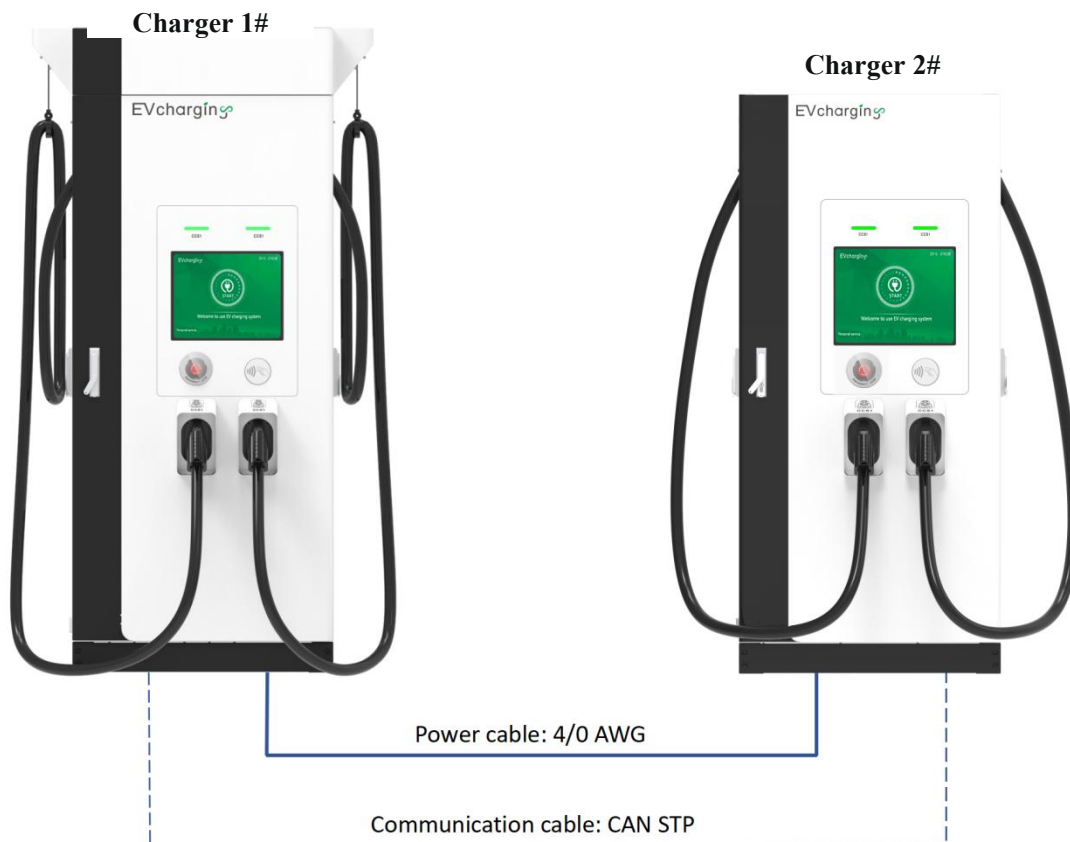

NOTE: only PRO version supports the parallel operation function.

5. Installation instructions

5.1 Preparation before installation

5.1.1 Electrical preparation

Specification of AC input cable: UL10269, 105°C, 600V



NOTE: According to the specifications of the input cable, single cable or double cables can be selected as the input cables.

The single cable is connected in single-wiring mode, and double cables are connected in double-wiring mode. For details, see 5.3.2 Electrical wiring.

Recommended AC input cables of European standard DC charger

Model	Specification of AC input cable	
	Single-wiring mode	Double-wiring mode
Atlas D80-US	1/0 AWG	2*3 AWG
Atlas D120-US	3/0 AWG	2*1 AWG
Atlas D160-US/ Atlas D160-US-PRO	4/0 AWG	2*1/0 AWG

Ethernet network cable (if network port is available): shielded network cable above Type 5.

5.1.2. Preparation of site and tools

Upon installing the charger, reserve enough floor space to facilitate the maintenance and operation.

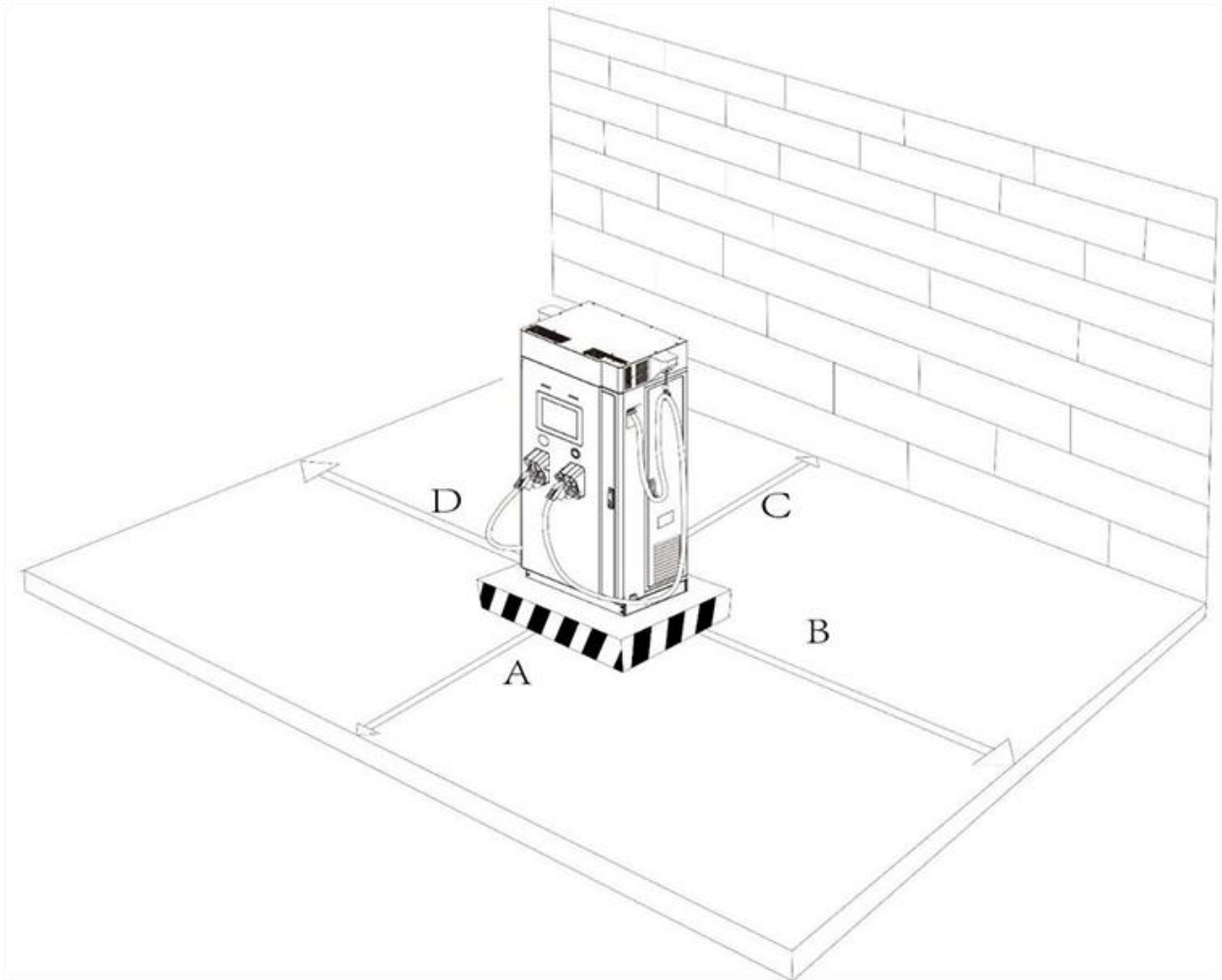

A: Space to open the front door. The front door of the charger should be more than 1000mm from the car parking space.

B: Space for air inlet and to open the right door. More than 800mm space should be reserved at right side.

C: Space for air inlet and to the rear wall. More than 200mm space should be reserved at the back.

D: Space for air inlet and to open the left door. More than 800mm space should be reserved at left side.



Note: Keep the air inlet and outlet unobstructed, and there should be no other objects within 500mm of the air inlet and outlet.

Required tools: forklift truck, torque wrench, screwdriver, wire stripper, terminal crimper, alcohol burner (or heat blower), hexagon key for terminal fixing, megohm meter and multimeter, and other auxiliary tools and parts.

5.2 Do a check before unpacking

During installation, follow the relevant information of 3. Safety Instructions.

5.2.1. Do a check on the transport sensors

1. Tilt sensor for detecting front side of packing
 If the sensors show a green indicator, it means normal status.
 If the sensors show a red indicator, it means abnormal status.
2. If the sensors show a red indicator, which means some abnormal condition has been caused for tilt during transport, with possibility to damage the charger, do the following steps:
 - a. Refuse to receipt the charger;
 - b. Remark the abnormal status on the shipment receipt;
 - c. Contact the manufacturer immediately.

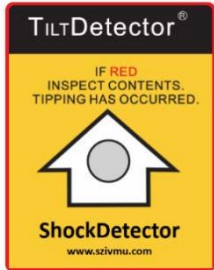
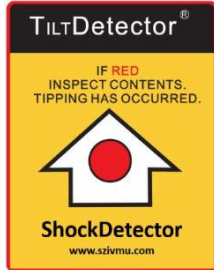

Normal status	Abnormal status
	

5.2.2. Unpacking

1. Check if the external packing is damaged;
2. Remove the external packing;
3. Check if the charger is scratched, dented, damaged;
4. Open the front door, right door, and left door of the charger, and check whether the internal parts are loose or fallen.



NOTE: Unpack the charging station by necessary tool. The packing is not openable only by hands. As the edge of the packaging is sharp, avoid injury. The packing is recycled to contribute to environmental protection.

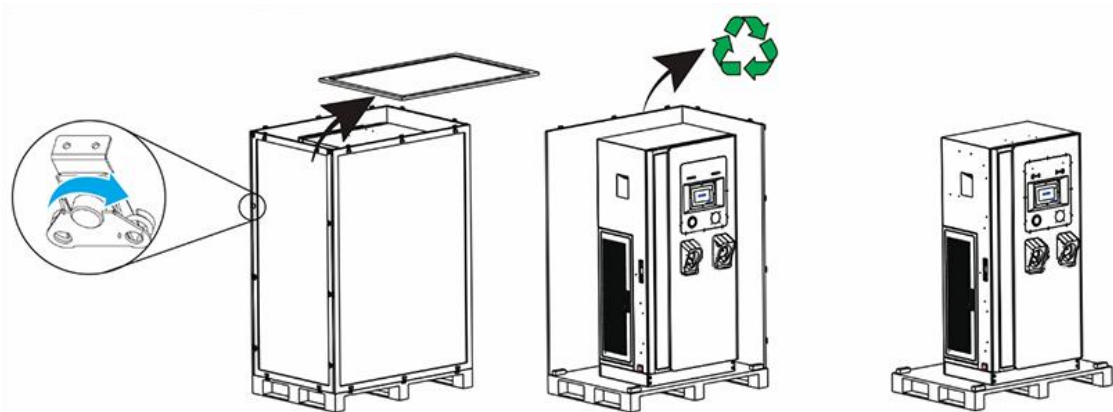

5.2.3. Inspection of accessories

1. Check if the model of the delivered charger is same with that shown in the order.
2. Check the accessories according to the order.

If you find that the number of accessories does not meet the order requirements, please contact the manufacturer.

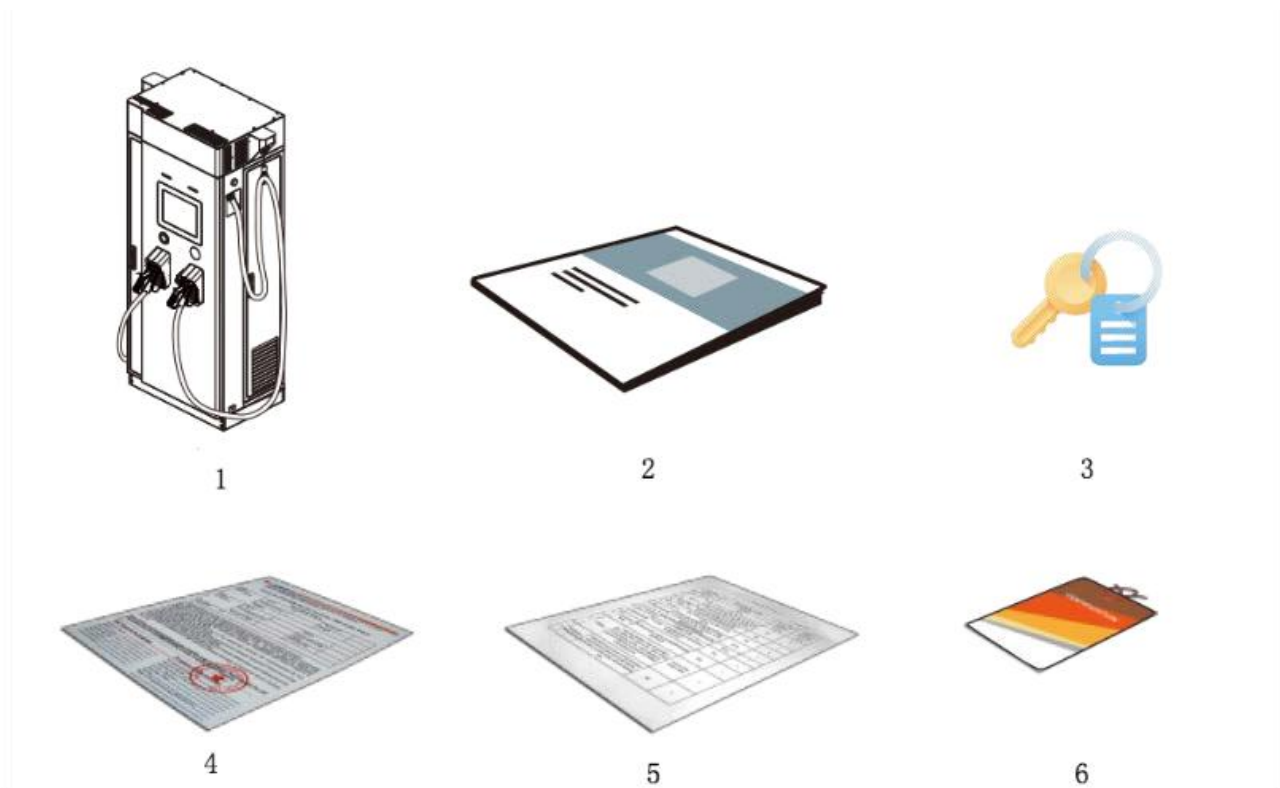
**Packing list**

No.	Items	Quantity
1	DC charger	1
2	User manual	1
3	Key	2 keys per lock, totally 6 keys
4	Warranty card	1
5	Delivery test report	1
6	Manufacturer certificate	1

5.3 Installation

5.3.1. Preparation of foundation and auxiliary materials

- 1) Preparation of foundation for charger: prepare the foundation of not less than 950 x 750mm 200mm (height), make a rectangular cable trough on the foundation, and ensure the installation surface is leveled;
- 2) Installation preparation: drill 4 x 75mm deep holes for M12 expansion bolts on the mounting surface, the expansion bolts should be exposed by 3-4 threads after tightening;
- 3) Installation: fix the charger by M12 304 stainless steel expansion bolt;
- 4) Schematic diagram of foundation:

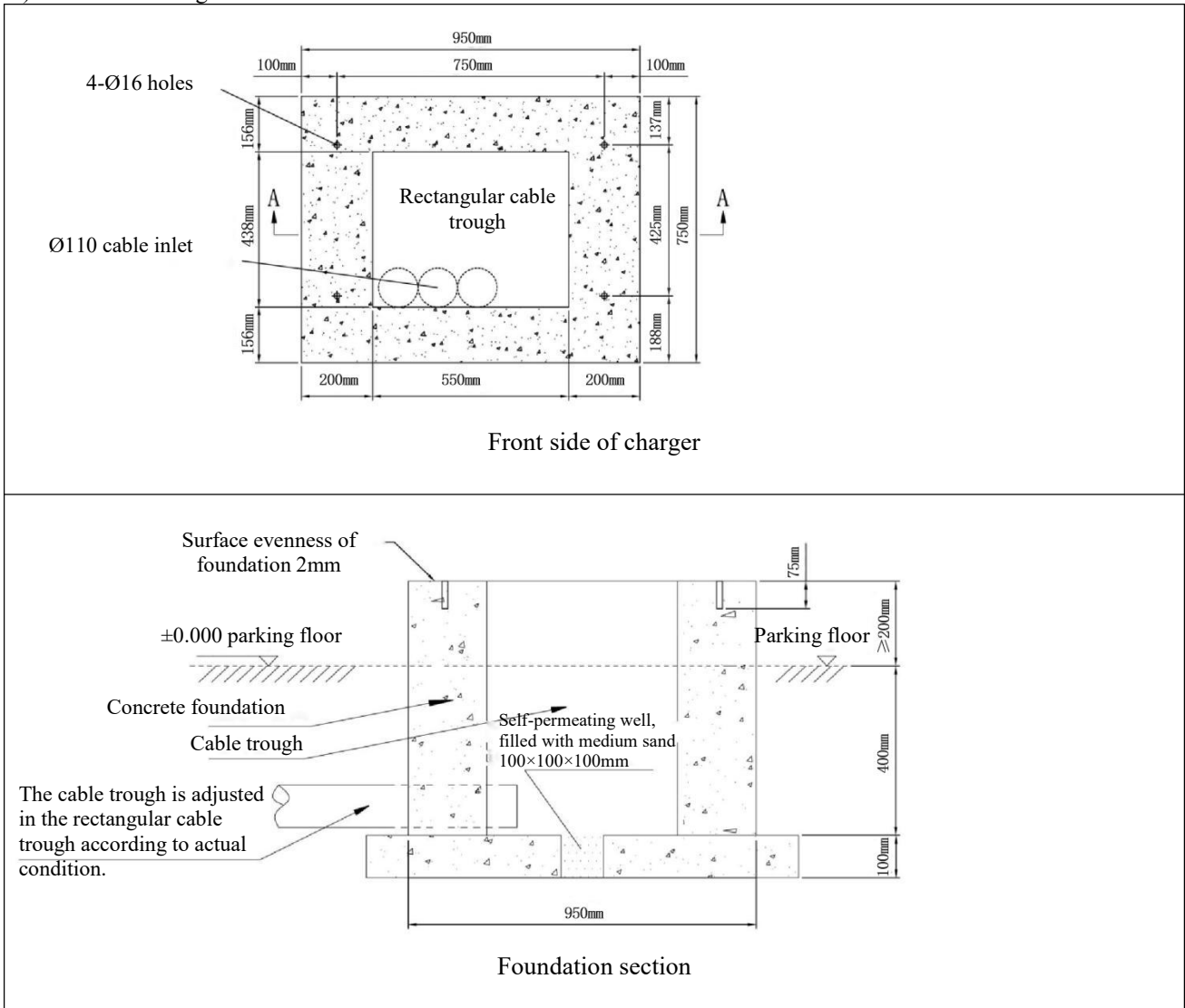

5.3.2. Electrical wiring

1. AC input wiring

Connect the AC input cables accordingly to the bus bar under the AC contactor.

Note:

① Connection order is L1-L2-L3-N-PE.

② Double wiring means two cables installed front and back at the bus bar.



③ Open the circuit breaker in the charge point before wiring. Use a multi-meter to ensure correct connection before powering on.

powering on.

④ Use a dedicated aluminum to copper wire adapter for connection to bus bar if AC input cable is aluminum wires.

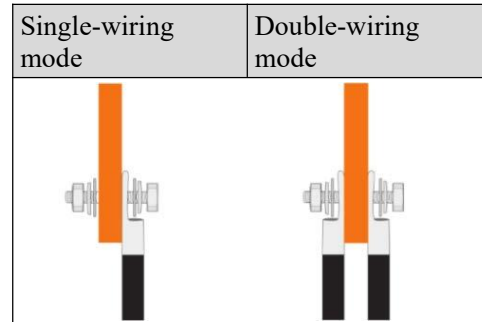

2. PE connection

① Connect the PE input cable to charger’s PE busbar.

② Connect the metal cabinet to the site’s PE grid.

3. Ethernet Connection

Connect the network cable of the J45 port to the gateway port of the switch.

5.4 Power on

1. Close the surge circuit breaker, circuit breaker for AC Socket (if any), control circuit breaker, residual-current device, and upper-level circuit breaker in sequence.

2. Check whether the status indicator and screen are faulty. If yes, see 8. Troubleshooting.

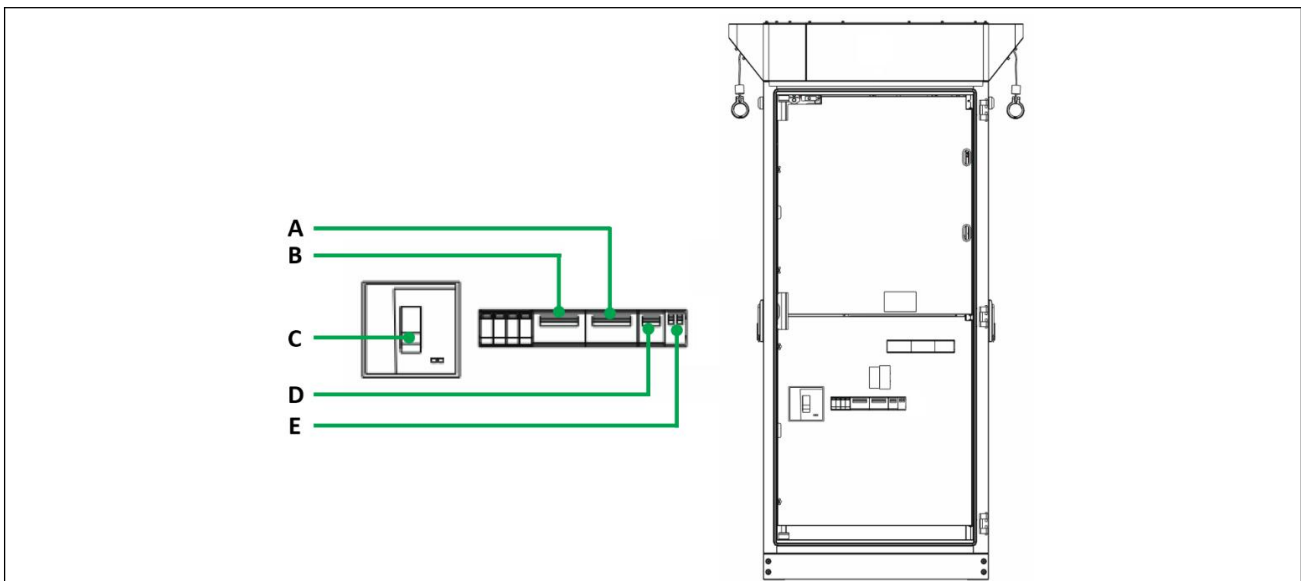

A	Circuit breaker for AC Socket(if any)	B	Surge circuit breaker	C	Manual switch AC input circuit breaker
D	Control circuit breaker	E	Residual-current device		

5.5 Network inspection

Check the network status of the charger according to the following figure:

Network connection status	4G status					
	Ethernet status					
	WiFi status					
	Legend	Connected with OCPP platform.	Disconnect from OCPP server (network available)	Disconnect from OCPP server (network unavailable - Local communication network connected)	Disconnect from OCPP server (network unavailable - Local communication network not connected)	4G card not inserted

5.6 Inspection of charging connector status

Check the status of the charging connector according to the following figure:

Connector status		Available to charge		Connector inserted		Start charging
		Charging		Stop charging		Charging completed
		Suspended		Reserved		Failed
		Unavailable				

5.7 Parameter setting

The parameter setting provided in this section is only for professionals. The parameter settings are not required for commissioning.

5.7.1 Language setting

Click the language switch button  on the home page and select the desired language in the pop-up box.



5.7.2. Function setting

The function setting can only be completed by professional operation and maintenance management personnel after login to avoid the failure of the charger to provide the expected functions due to parameter modification by common users.

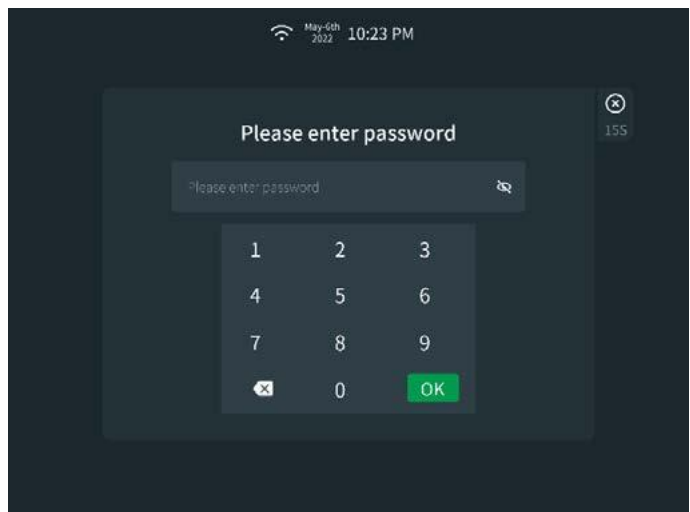

5.7.2.1. Log in

Click  in the lower left corner of the main interface and select settings to enter the system setting interface. Log in the interface by the account password.



WARNING: the parameters have been set before delivery, please do not change the parameters.

Function selection: select the function after successful login.

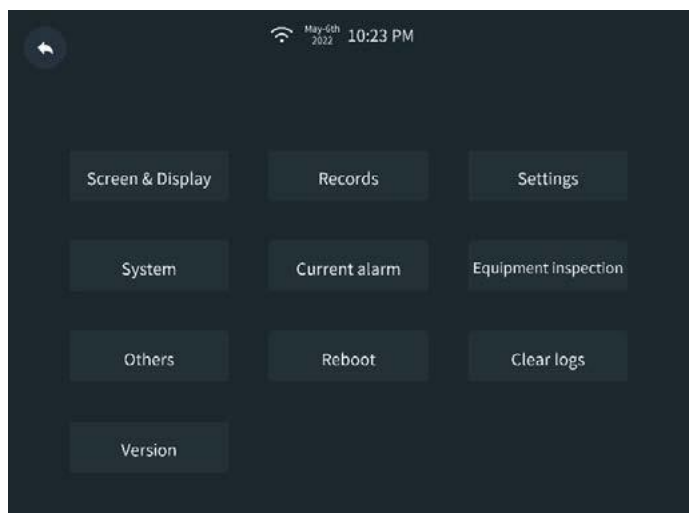

5.7.2.2. Screen setting

Company: customize the company name and LOGO;

Displayed setting: set screen brightness and theme;

Availability: set the availability of the charging connectors;

Time zone: set time and time zone;

Screen saver: set the screen saver. Pictures or videos can be uploaded for advertising rotation when the screen displays the standby page.

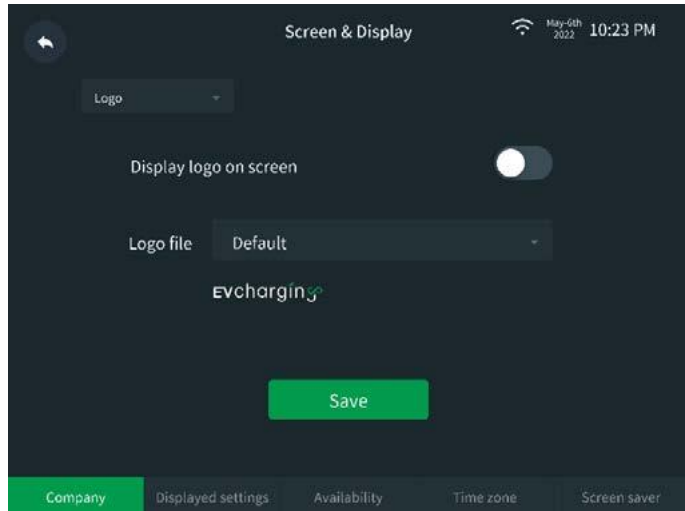

5.7.2.3. System setting

Charger ID: each charger has a sole code, which correspond to the type plate;

Asset code: name of fixed asset;

Communication code: code to establish connection with the platform;

Parameter sync: set the parameters of the charger;

Debugging: debug and start the charging;

Date: set the date;

Update: upgrade the firmware of the charger.



NOTE: in the debugging mode, the charger may start the charging without communication with the BMS.

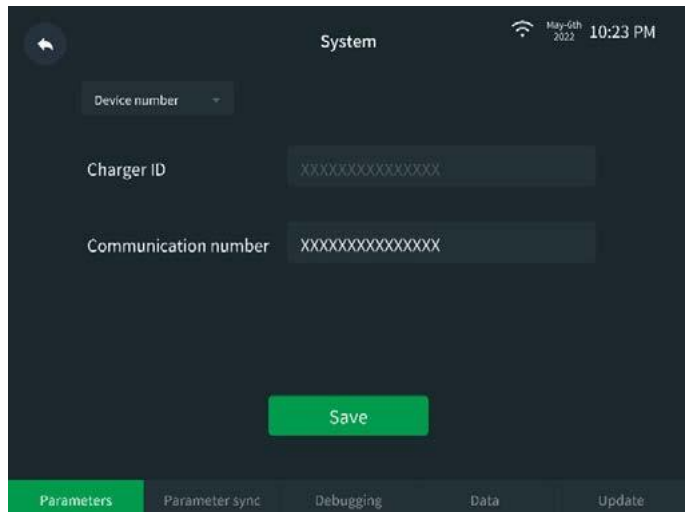

5.7.2.4. General setting

IP: configuration of network parameters for the operation server when the charging pile is connected to the operation server;

Network: set the local network parameters of the charger;

CCU configuration: parameter settings associated with the charging connector, e.g. light board information, module information, power meter information, etc.

Charging mode: set the charging mode for the charger, and modify the sequence for the charging modes;

Function setting: block some functions or alarms;

Card reader: set the card reader.

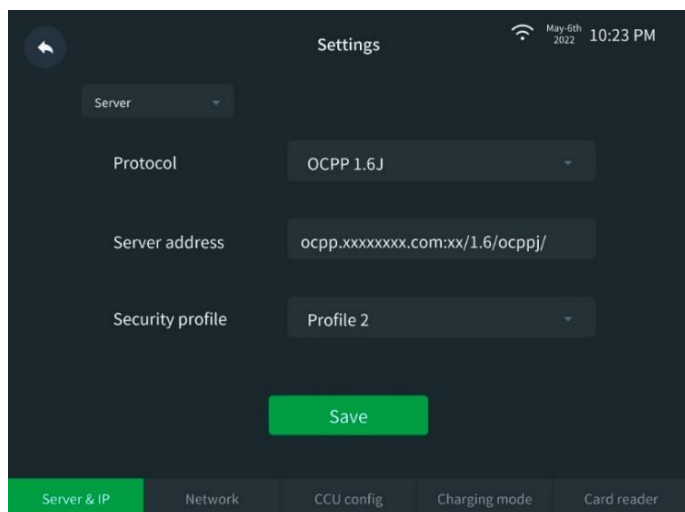

5.7.2.5. View records

Charging record: filter and view the charging record according to the connector number and the time, view the charging details by clicking the charging records, and clear the charging record (it is recommended not to clear the charging record easily);

Error record: filter and view the alarm record according to the connector number and the time.

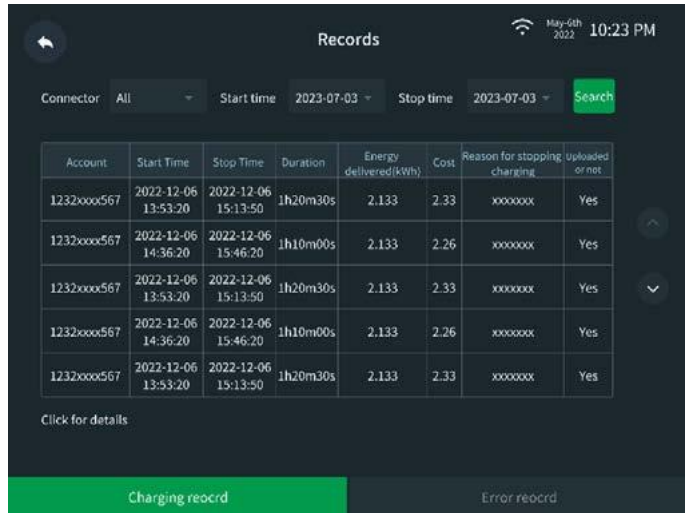

6. Operation instructions

Please carefully read [3. Safety instructions](#) of this document before using the charger. In case of difference between the interface and the actual display, contact the manufacturer.

6.1 Software version

Click  in the lower left corner of the main interface and select “Charger info” to display the software version information.



6.2 Charging operation

Step 1: take down the charging connector from the charger, connect the plug of the charging connector to the charging socket of an electric vehicle, and confirm that the connection is reliable; Click the monitoring screen to enter the following main information interface.



Step 2:

(1) Select the charging mode: select one of charging cards, mobile APP, credit card, VIN code, password (offline) and other ways for charging as needed.

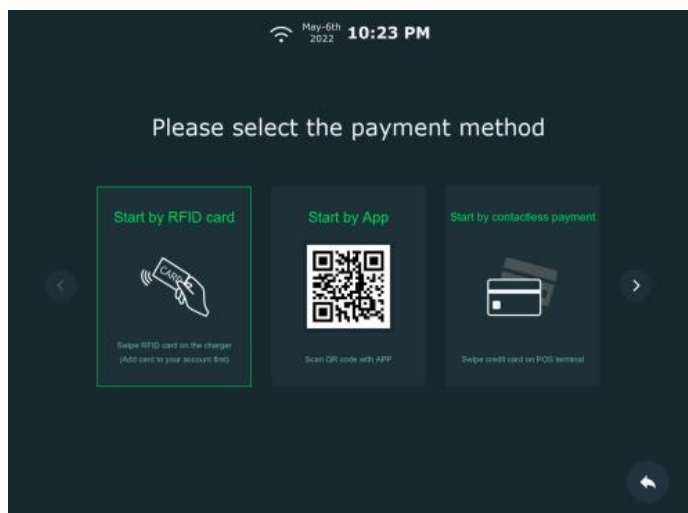

(2) After swiping the charging card or credit card successfully or typing the VIN code, the verification page is displayed.

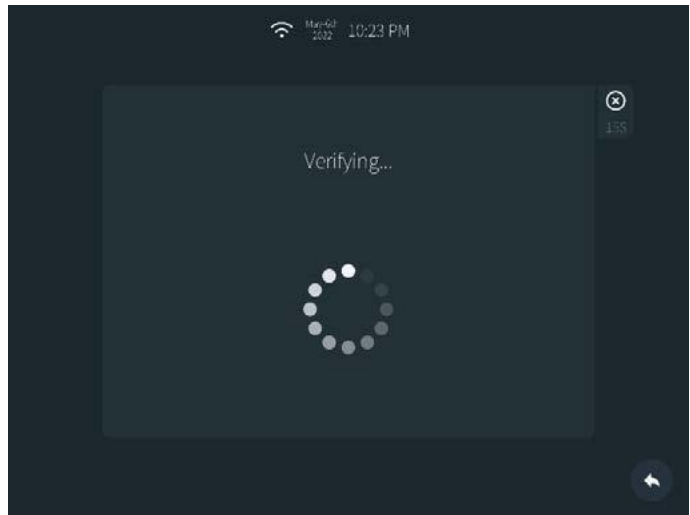

(3) Starting interface: after the authorization succeeded or the code is scanned by APP to send the starting command, the charger will enter the starting state.

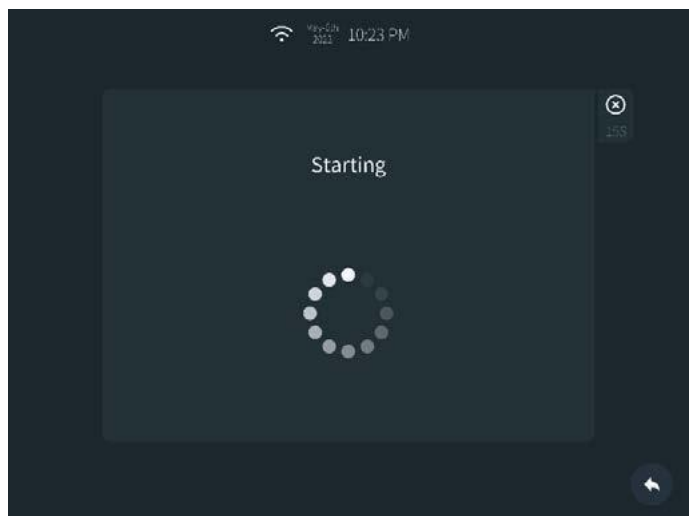

(4) Charging interface: enter the charging interface after successful startup.

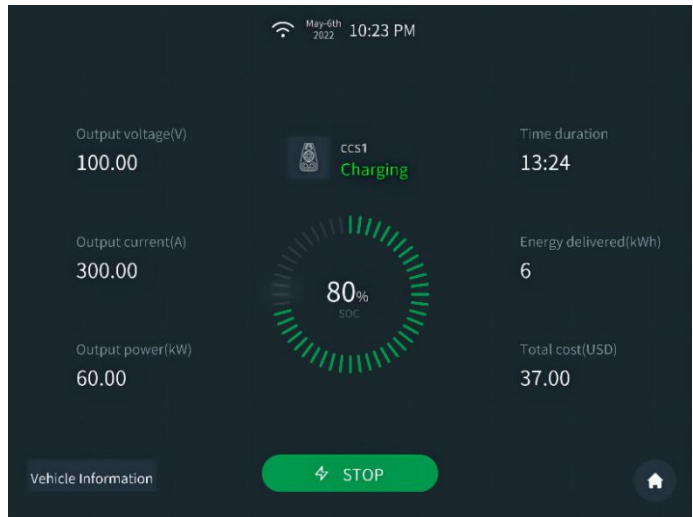

(5) Stop charging

① If charging by APP, stop the charging by the APP, and for charging by the credit card, and the VIN code, click the “Stop” button on the charging interface to stop the charging. For charging by the charging card, click the “Stop” and swipe the charging card again to stop the charging.

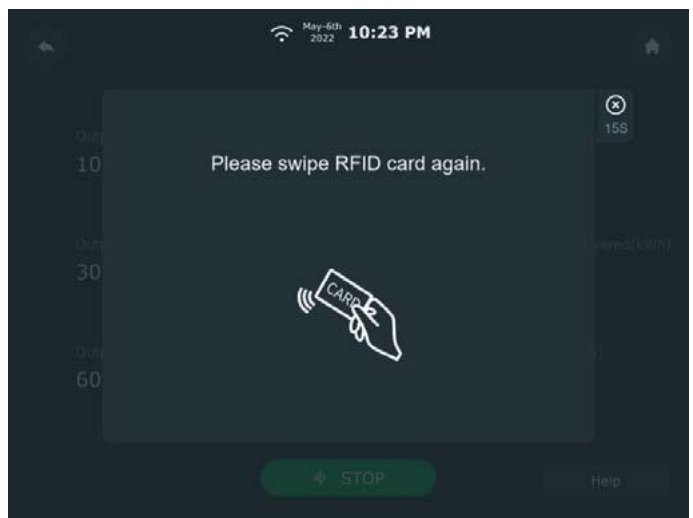

② If charging by the password, click the “Stop” and enter the password again to stop the charging.

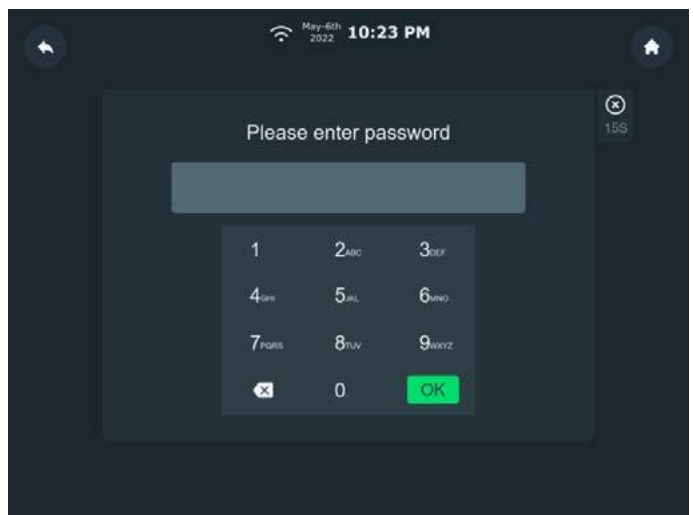

③ After the authorization has been passed, the charging is terminated.

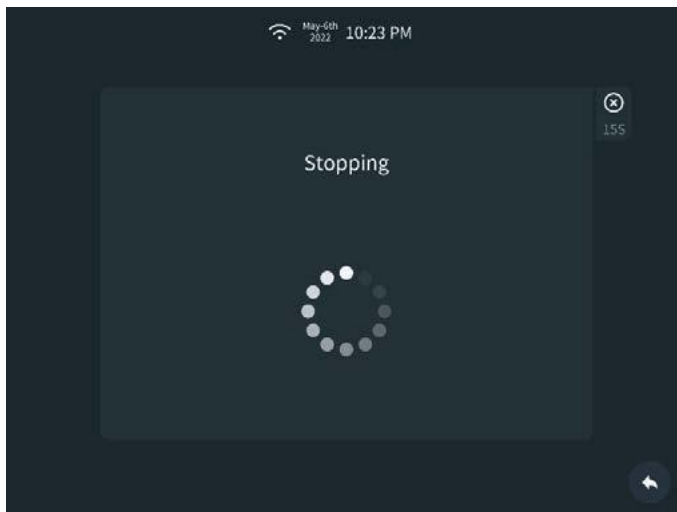

(6) Complete charging

Click “Stop” on the APP or swipe the card to stop charging and complete settlement → unplug the charging connector → put the connector on the connector holder → complete the charging process.

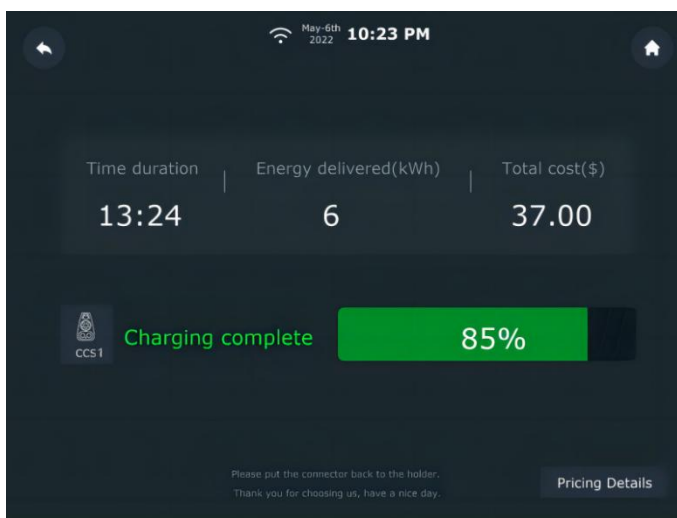

i **NOTE:** in case of an emergency during the charging process, such as abnormal noise, spark, short circuit of power line, etc., please press the emergency button, and then pull out the charging plug, and immediately contact the onsite management personnel.

7. Maintenance instruction

7.1 Maintenance schedule

Due to the impact of ambient temperature, humidity, dust and vibration, the internal components of the charger will age or be damaged during daily operation, resulting in potential failures of the charger. In order to extend the service life of the charger and ensure its more reliably operation, the charger shall be maintained during daily operation. The following describes some specific maintenance items and maintenance period.



WARNING: Only professional electrical engineers or electricians authorized by us are allowed to maintain the charger. After the maintenance, do not leave the tool in the charger, otherwise it is possible to cause personal injury or damage to the charger!

Before maintaining the charger, please make sure that the following work is completed:

- 1) In the standby state of the charger, place the charging connector in the charging connector holder, disconnect the external input power supply from the charger, open the internal input circuit breaker of the charger, and wait for at least 15 minutes.
- 2) Open the cabinet door, and use the multimeter to measure the voltage between input and output terminals and between the terminals and the ground, so as to ensure that no dangerous voltage occurs.

No.	Inspection items	Inspection method	Maintenance period
1	System operating status and operating environment	Observe whether the operating status of the charger is abnormal in standby and charging modes. 1. Check the charger for unusual noise during operation. 2. Check whether the indicator status and the parameters are normal during the operation. 3. Visually check whether the main components are normal operating. 4. Check whether the temperature of the charger enclosure is normal, and use a thermal imaging camera to monitor the heating of the system. 5. Observe whether the air in and out is normal. 6. Check the ambient environment for humidity and dust, and the air inlet filter for normal function. Caution: the air inlet must be checked for ventilation. Otherwise, the charging module may be not cooled effectively, and may fail due to overheating.	Once every month
2	System cleanness	After turning off the charger, check the circuit board and the components for cleanness. 1. Check for surface dust. If necessary, clean by a vacuum cleaner or replace. 2. Replace or clean the air filter.	At least once every 1-3 months (depending on the dust content of the environment)
3	Cable connection	After turning off the charger, check the power cable for stable connection. If loose, tighten it according to the specified torque. 1. Check the power and control cables for any damage, and mainly check the cable for any cut sign on the cable sheath touching the metal surface. 2. Check whether the insulation tape on the wiring terminal of the power cable is damaged.	Half a year after commissioning; once every 6-12 months
4	Terminal and wiring connections	After turning off the charger: 1. Check whether the screws of the control terminal are loose. If yes, tighten the screws with the screwdriver. 2. Check whether the main loop terminal is in poor contact and whether the screws are overheating. 3. Visually check terminal connections and cable distribution.	Once a year

5	Maintenance and replacement of cooling fan	<ol style="list-style-type: none"> 1. After turning off the charger, check the fan blades for cracks. 2. Check the fan for abnormal noise and failure in the charging mode. If the fan has abnormal conditions, replace the fan in time. 	Once a year
6	Circuit breaker, AC contactor	<ol style="list-style-type: none"> 1. Routinely check all metal components for corrosion. 2. Check the AC contactor (auxiliary switch and micro switch) to ensure its good mechanical operation. 3. Simulate the current leakage of the circuit breaker and press the circuit breaker test button to check whether the circuit breaker is tripping normally. 	Once every 6-12 months
7	Surge protective device	Visually check the indicator window of the surge protective device module. If the indicator window displays green, the surge protective device is normal. If the indicator window displays red, replace the surge protective device.	Once every 6 months
8	Charging connector	<ol style="list-style-type: none"> 1. Check the charging connector for good appearance and the connector head for damage, and the connector needle for binding or damage. 2. Check the cable sheath of the charging connector cable for damage and good appearance. 	Once every month
9	Charging module	In the charging and standby states, check the indicator status during the operation of the charging module, and the internal fan for normal operation.	Once every month
10	Safety function	<p>Check the emergency stop button for normal stop function:</p> <ol style="list-style-type: none"> 1. In the standby mode, press the emergency stop button, and check whether the emergency stop fault is displayed and the indicator light is normally on in red. 2. In the charging mode, press the emergency stop button, and check whether the charger stops the charging. 	Once every 6 months

Please carefully read [3. Safety Instructions](#) of this document before maintaining the charger.

7.2 Cleanness of cabinet

Before cleaning the cabinet, disconnect the AC input circuit breaker and the superior circuit breaker.

7.2.1. Dust removal

Remove the dirt from the surface with low pressure tap water. Do not use abrasive cleaning tools to avoid wearing the cabinet.

7.2.2. Rust removal

When Atlas DC charger is placed in high humidity and high salt environment, it is possible to cause the rust on the metal welding points. The rust does not affect the integrity of the cabinet, and can be removed with a mild cleaning agent. In addition, if you want to use anti-rust paint, please consult the manufacturer in advance.

7.3 Inspection of charger body

The inspection of the charger should cover the following parts:

1. Charging connector cable and connector head: check them for cracks or other obvious damage;
2. Touch screen: check it for cracks and response sensitivity;
3. Cabinet coating: check it for cracks or other obvious damage;
4. Charger body: check it for the cracks or rust resulting in water inflow.

If the above defects are found during checking, please contact the manufacturer for after-sales treatment.

7.4 Cleanness and replacement of filter cotton

1. Open the left door and remove the filter net of the air inlet on the left door to see the filter cotton;
2. Remove the old filter cotton, and install the new filter cotton;
3. Remove the filter net of the air inlet at the back of the housing to see the filter cotton;
4. Remove the old filter cotton in the direction shown in the figure, and install the new filter cotton;
5. Open the right door and remove the filter net of the air inlet on the right door to see the filter cotton;
6. Remove the old filter cotton, and install the new filter cotton.

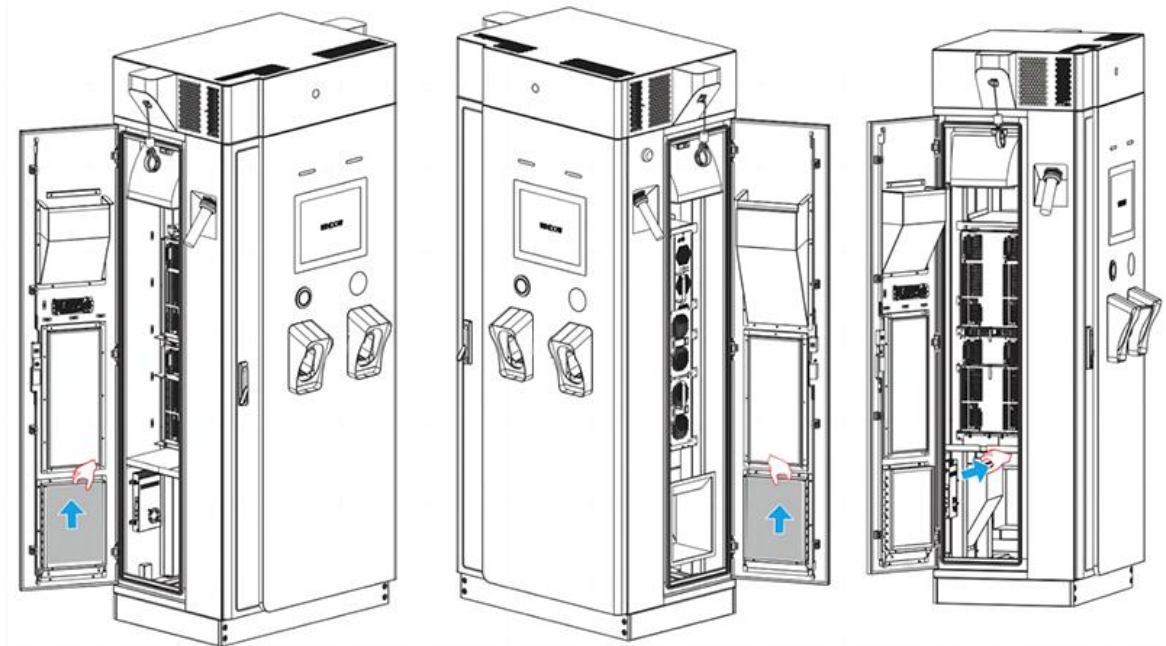

8. Troubleshooting

8.1 Troubleshooting procedure

During the installation and commissioning process, it is normal for the monitoring module to give an alarm. This chapter describes how to identify and remove the problem. You can view the real-time alarm information of the charger on the screen.

If you cannot find a solution for the problem, contact your local representative of the manufacturer.

8.2 Troubleshooting table

Problem	Possible causes	Possible solution
The touchscreen is black and it does not light up when you touch it.	<ol style="list-style-type: none"> Control circuit breaker disconnected There is a problem with the AC input power supply. 	<ol style="list-style-type: none"> Check whether the control circuit breaker is closed. For details, see 5.4 Power on. Check whether the input cable is properly and reliably connected. Check whether there is current on the input terminal.
The charging connector can not be pulled out after charging	CCS1 connector	<ol style="list-style-type: none"> Make sure charging has stopped (press the emergency stop button of the charger if necessary). Check if the vehicle has been unlocked (when the vehicle is locked and the door cannot be opened, the vehicle will not unlock the connector even if charging is stopped) Check the vehicle user manual for emergency unlock guidance. Stop charging and unlock connector via the vehicle.
AC input under-voltage	<ol style="list-style-type: none"> The voltage of the local grid fails to fall within the input voltage range of the charger. The voltage of the local grid is unstable, and its fluctuation greatly exceeds the input voltage range of the charger. Abnormal sampling is caused due to the damage of the charger. 	<ol style="list-style-type: none"> Ensure that the input voltage is within the specified range. Use the multimeter to check whether the input voltage is within the specified range. If the abnormal sampling is caused due to the damage of the charger, contact the local distributor.
AC input over-voltage		
Ground fault	<ol style="list-style-type: none"> The ground cable is incorrectly connected to the charger. The power supply fails, and the ground voltage is too high. 	<ol style="list-style-type: none"> Reconnect the PE cable to the charger. For details, see Section 5.3.2. Use the multimeter to measure the voltage between N wire and PE wire. The voltage between normal N wire and PE wire does not exceed 2V.
Emergency stop fault	Emergency stop button pressed	Turn the emergency stop button clockwise until the emergency stop button bounces back to its initial state.
Surge protective device failure	<ol style="list-style-type: none"> The charger is damaged by lightning due to the failure of the surge protective device. The surge protective device is not securely installed. 	<ol style="list-style-type: none"> Check the status window of the surge protective device. If the status window is red, the surge protective device is faulty. Replace the surge protective device. Turn off the charger, replace the surge protective device, and restart the charger.
Access control failure	The door of the charger is not fully closed.	Close the main, left and right doors of the charger completely.

Insulation detection failure	1. System insulation failure 2. Insulation failure of electric vehicle	1. Clean the charger and remove the dust in the charging station. 2. Check the charging connector for foreign matters, water, etc. 3. Charge another electric vehicle to check whether the insulation failure is reported.
AC input circuit breaker failure	AC circuit breaker disconnected	1. Check whether the protective trip of the AC circuit breaker is caused by current leakage or short circuit. 2. If not, close the AC circuit breaker and check whether the failure persists.

9. Contact

EV Charging Clean Energy Technology Co., Ltd.

Company address: 3rd Floor Building C-1, No.6 Northern Industry Road, Songshan Lake Sci&Tech Industrial Park, Dongguan city, Guangdong Province, China

Production address: 3rd Floor Building C-1, No.6 Northern Industry Road, Songshan Lake Sci&Tech Industrial Park, Dongguan city, Guangdong Province, China

Website: www.evchargingplus.com

Email: evservice@evchargingplus.com

Tel: 0769-22897777

Copyright:

All rights to copyrights, registered trademarks, and trademarks reside with their respective owners.

Copyright ©EV Charging Clean Energy Technology Co., Ltd. All rights reserved.